

DOOSAN

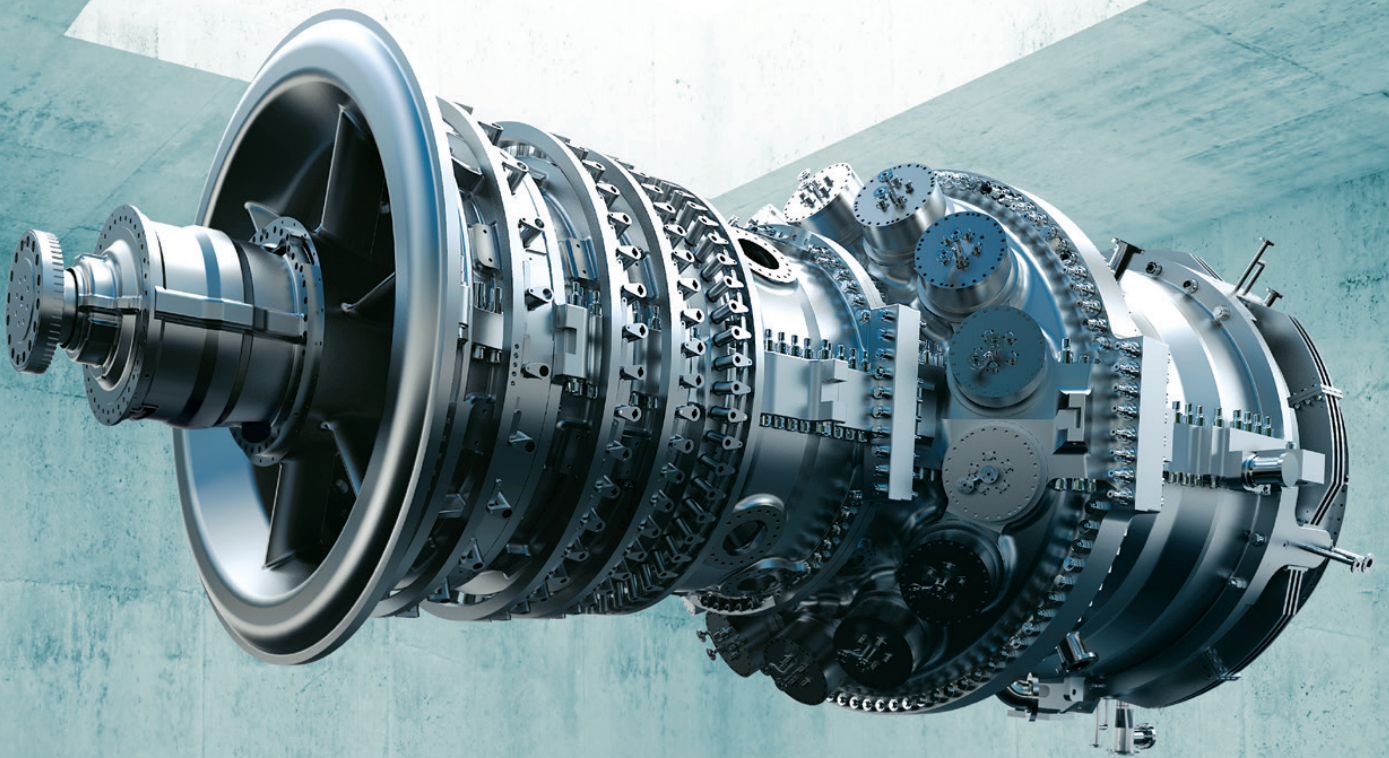

Powering tomorrow by innovation

Doosan gas turbine

Global leader in power & water

Doosan has long strived to create a new and innovative future. Our strong commitment to the future is embedded in our product and business portfolio, from consumer goods to the equipment and parts for basic industries.

The highest standard of technology and quality is the basic strength we must build on, and our efforts to create sustainable outputs and build a global network aiming for a peaceful coexistence can add more value to our products.

Doosan's gas turbines reflect our perspective of the world. They are manufactured based on our outstanding technical expertise, proven through our long history and experience. The combined efforts of Global R&D Centers and technical experts have led to the successful development of outputs that are customer and environment-friendly. The products created by Doosan will provide customers with experiences that are both new and familiar, bringing them closer to an innovative future.



04.
Technology



12.
Infrastructure



20.
Service

MACHINE NUMBER: S/N 212793

CB54684Q

Production Capacity: 409/day

Uptime: 99%

Energy State : Active

Pressure : 42/3

Auto Errors : 0

CONNECTED

SYSTEM

- Part 02: 98% BN298364S
- Part 03: 95% LW234568F
- Part 04: 99% CB54684Q
- Part 05: 97% AA31534H

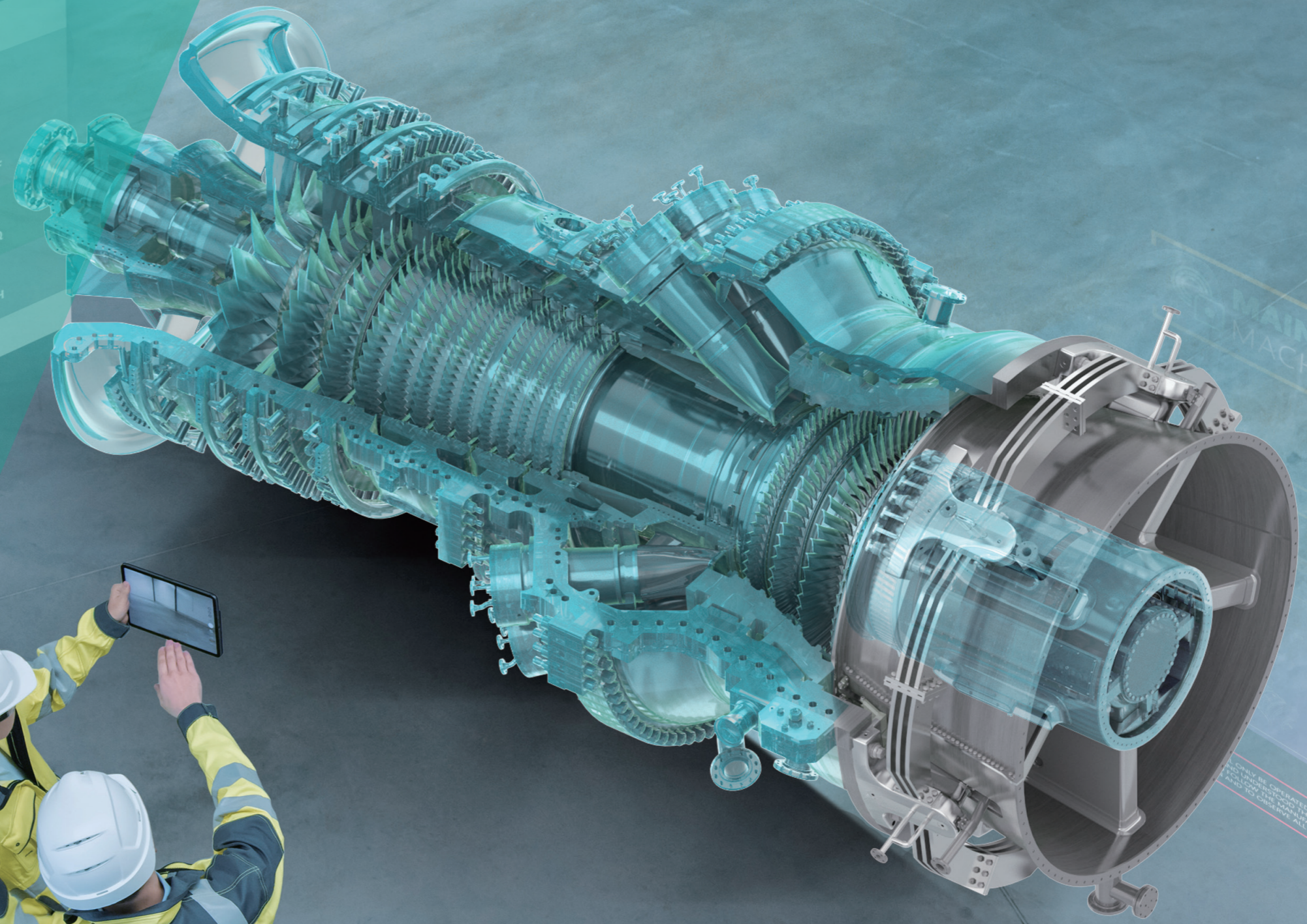

Technology

Doosan gas turbine technology

Doosan gas turbine

The demand for electricity will continue to grow as the economy and industry develop rapidly, technologies innovate and improve, and population grows steadily. However, many places around the world still cannot enjoy the benefits of electricity due to regional, technological and financial limitations. On the other hand, environmental pollution and global warming are unavoidable challenges that we are also faced with. Therefore, it is important to find a sustainable, accessible and eco-friendly way to produce electricity. Accessibility can be described by terms such as customer focus, convenient operation, and RMS (Remote Monitoring System). Eco-friendliness is equivalent to keywords such as low-carbon, high energy efficiency, and optimization. Doosan's technologies focus on these words.

The history of our gas turbine development dates back to the 1990s. In 2005, our technical capability was proven by completing the development of a 5MW gas turbine with our own technology. Equipped with the technologies to design and produce Heat Recovery System Generator (HRSG), boilers, steam turbines, and Balance of Plant (BOP), we have achieved strong track records in the Simple and Combined Power Plant markets. Our outstanding performance and quality management have been highly evaluated by our customers, and we have grown to become their global partner in the power industry.

In line with the market changes, we started development of a large sized, high efficiency 270MW gas turbine from 2013. This is part of Doosan's new businesses, and accounts for the greatest part of our new growth portfolio. Gas turbine development began with the securing and development of our own technical expertise and manpower, and by establishing manufacturing facilities, process management, and test shop all in-house, we have created a system that allows an α to Ω technology implementation in one place.

Now, Doosan is developing an upgraded model from the initial one, which is a 380MW class, boasting of world-class performance. We plan to carry out a pilot project, after proving the technology of the upgraded model through multiple phases of verification process. As this project will be led by the South Korean government, which is advocating green policies, it will help us promote industry-academia cooperation and public-private partnerships with many experts around the world. The gas turbines developed and manufactured by Doosan will certainly meet up to the needs and expectations of the market.

We are expanding the scope of our technology development from gas turbines to also include hot parts, HRSGs and steam turbines. With the entire suite of products and technologies, we can provide safe and efficient Combined Cycle Power Plant services. We will always aim to provide services that would exceed customer expectations, by widening our business scope into performance improvement or services for the models manufactured by other OEM providers.

We produce competitive gas turbines with unmatched power capacity, which are designed to meet customers' needs and expectations.

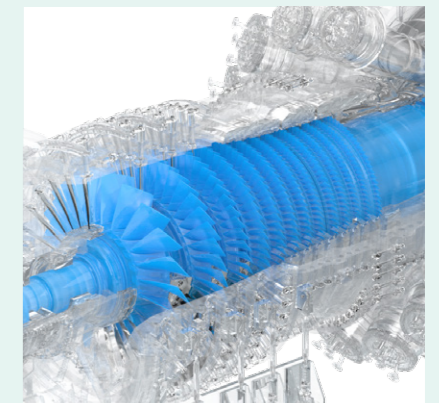
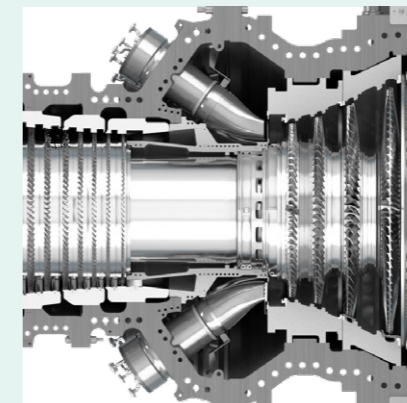
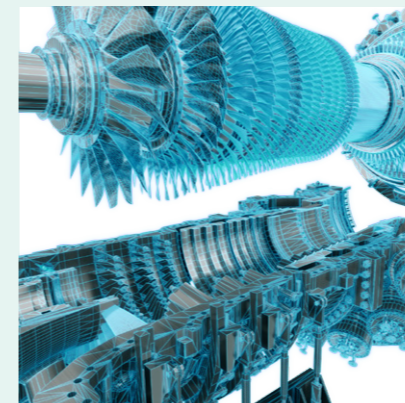
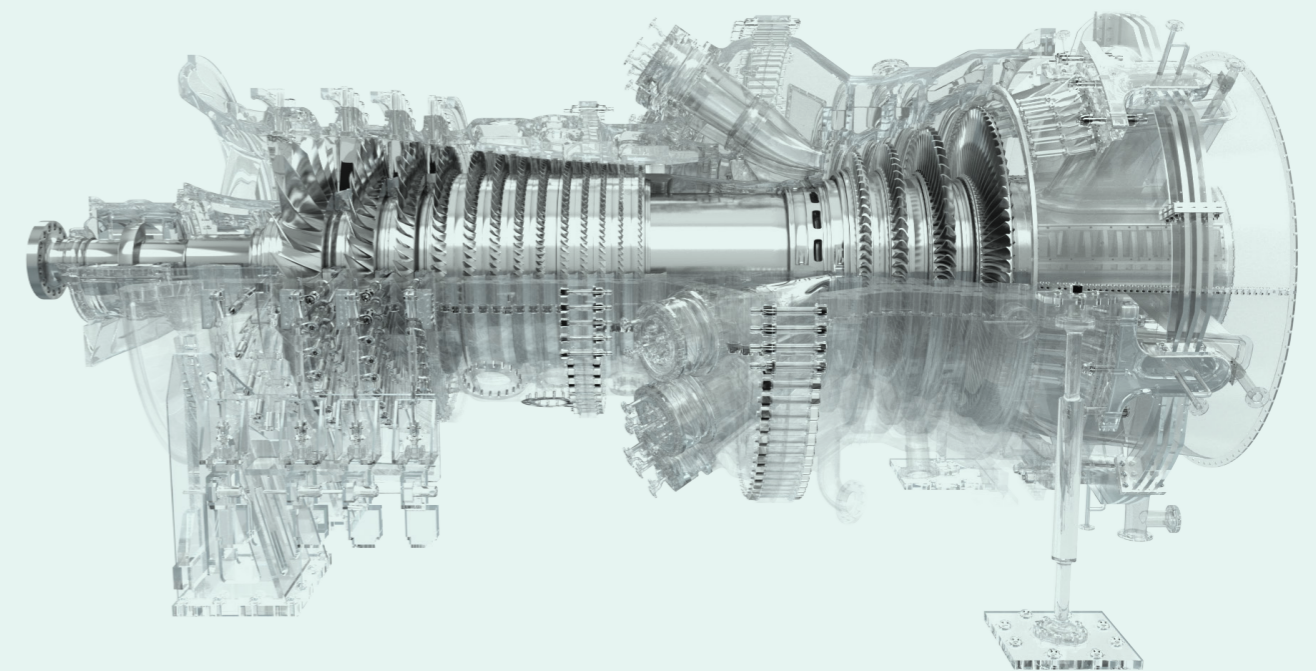

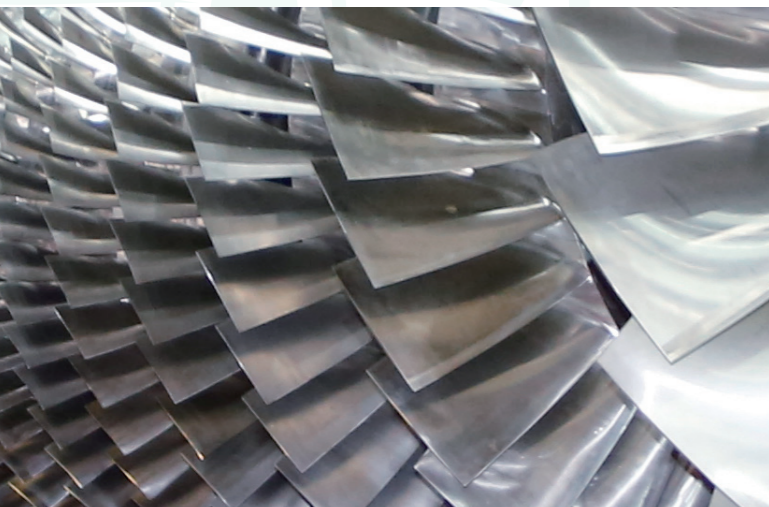

COMPRESSOR

The air compressor is designed to operate with the highest performance, suited to the changes in ambient temperature and various load operating conditions with multi-stage VGVs. Axial and circumferential dovetail design ensures structural stability, and makes it more convenient to perform maintenance work such as on-site replacements. Cantilever vanes were used for easy assembly, and bowed design was applied for wider operation area and enhanced reliability.



COMBUSTOR

The advanced premixed combustor developed by Doosan shows not only the state-of-the-art emission performance such as nitro dioxides emission but also an extremely low turn down ratio operating performance. It presents wide fuel flexibility performance including liquid fuel and various low caloric value fuels. All design targets were validated through combustion test processes.



TURBINE

The four-stage turbine, comprising rotating blades, stationary vanes and ring segments, is designed to maximize power output and efficiency. Steady state CFD is used for the design iterations, while a time accurate transient model is used to verify performance and investigate the results for circumferential variations. The blades are designed with state-of-the-art 3D-aero design features.

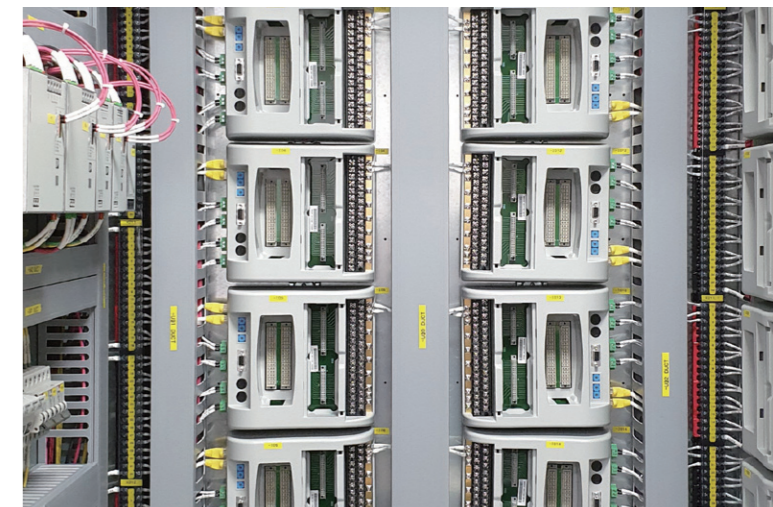

CONTROL SYSTEM

GUARDIAN™ control system is a flexible platform used in steam and gas turbine application. It features simple dual redundant controller and high-speed ethernet based I/O which provides a easy integration and extension. GUARDIAN™ Software provides a fully integrated engineering package for system configuration, logic programing, alarm and event diagnostics.

Beyond technology

Doosan DGT6-300H Series, Korea's first H-class gas turbines, boast of high efficiency with a power output range spanning from 270MW to 380MW. Our inventive DOCS (Doosan Optimized Clearance Control System) has been applied to minimize combustion gas leakage, to enable quick-start up and to maximize efficiency and flexibility of operation. Advanced seal technology and turbine cooling air cooled off through heat exchanger further enhance the performance and reliability of Doosan gas turbines. Especially, the cutting-edge PCHE (Printed Circuit Heat Exchanger) has been applied to cool off turbine cooling air, which is only five percent the size of conventional heat exchangers.

		DGT6-300H.S1	DGT6-300H.S2
Simple Cycle	Output (MW)	270	380
	Efficiency (%)	> 40.0	> 43.0
Emission	Nox (ppm) (Without SCR)	15	30
	CO (ppm)	10	10
Operational Flexibility	Starting Time Normal/Fast (min.)	20 / 12	20 / 12
	Turn Down (%)	40	40
	Ramp Rate (MW/min)	40	55

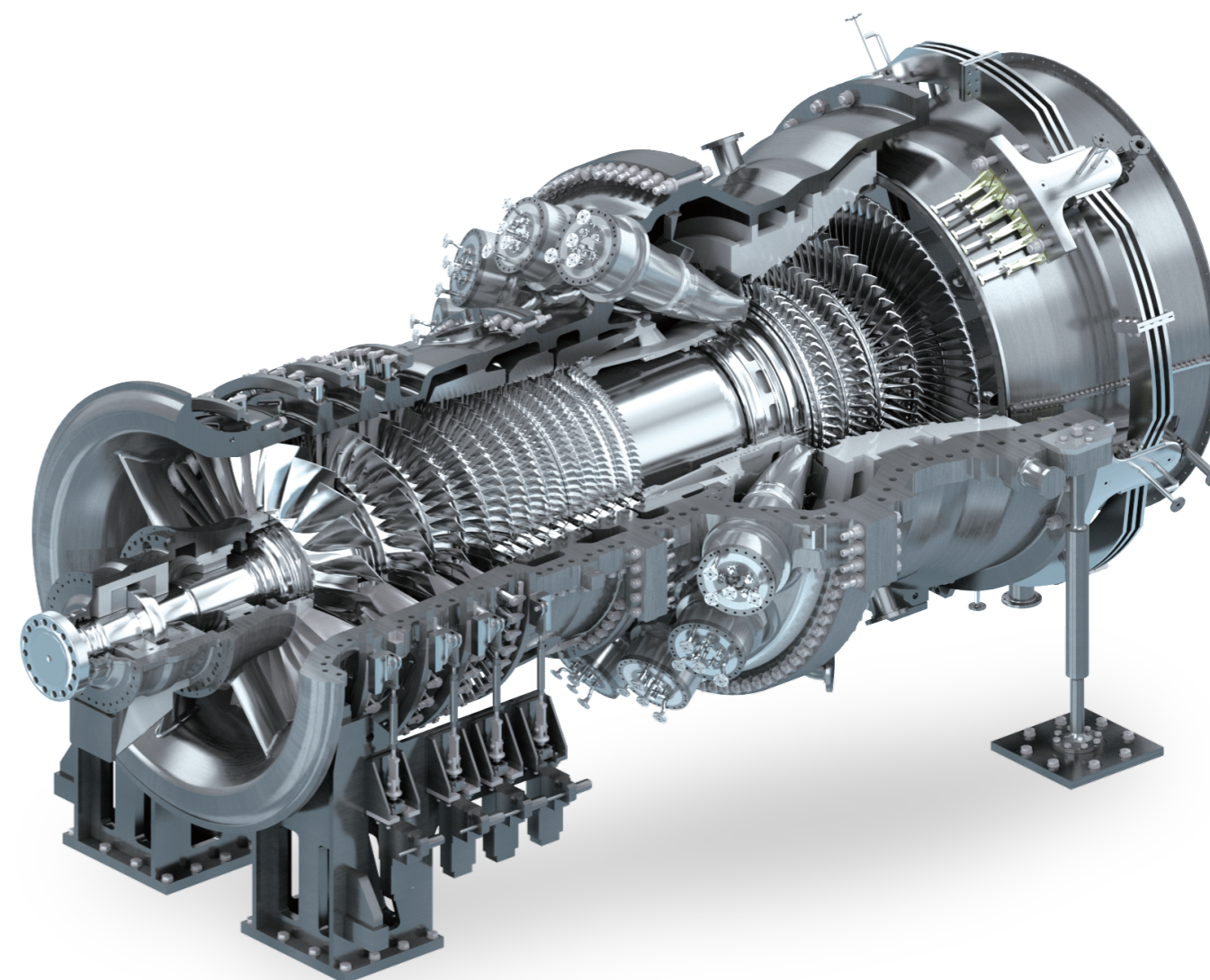

Flexibility in combined cycle

Doosan has the OEM technologies for steam turbines, generators and control system (GUARDIAN™) as well as various sources of HRSG supply, which are core equipment of CCPP (Combined Cycle Power Plants) along with gas turbines. The strong network of engineers built within the company enables them to closely cooperate with one another and promptly respond to any situations. They can reflect site-specific conditions in CCPP designs, thereby optimizing the designs and returning the benefits to customers. Furthermore, these products are manufactured in a single location, allowing a seamless delivery of all customer services including product maintenance and transportation.

1 on 1 GTCC Configuration	DGT6-300H.S1	DGT6-300H.S2	
	Output (MW)	> 400	> 570
	Efficiency (%)	> 60.0%	> 63.0%
	Steam Turbine Type	DST-S10 / DST-S20	DST-S10 / DST-S20
	Approximate Size of Power Block (m)	156 x 122	156 x 122

2 on 1 GTCC Configuration	DGT6-300H.S1	DGT6-300H.S2	
	Output (MW)	> 800	> 1,140
	Efficiency (%)	> 60.0%	> 63.0%
	Steam Turbine Type	DST-S20 / DST-S30	DST-S20 / DST-S30
	Approximate Size of Power Block (m)	164 x 168	164 x 168

* Power block : GTG, HRSG, STG and all related equipment including auxiliary systems.

POWER BLOCK

Power Block is the largest scope of supply that can guarantee unit performance. It reflects customer requirements and site conditions similarly with EPC, but supply scope, guarantee items and follow-up management can be customized to customer requests. Power Block includes gas turbines, HRSG, steam turbines and other auxiliary systems. In case a building construction is required, we provide site survey, erection and construction as a turnkey solution.

Global interest in Doosan steam turbines is rising every year, resulting in a rapid increase in our market share. Today, we are the most sought-after supplier of steam turbines from 10MW, linked with gas turbines and auxiliaries.

Our generators, available from 100MW, also boast of unparalleled quality and the most up-to-date technologies.

Our condenser designs, which have been built through decades of experiences, satisfy all customer requirements regarding size, price, lay-out and overall cycle optimization. Our condensers are compliant with all standards generally applied to pressure equipment, including PED, EN Code, ASME Code and AD-Merkblatt.

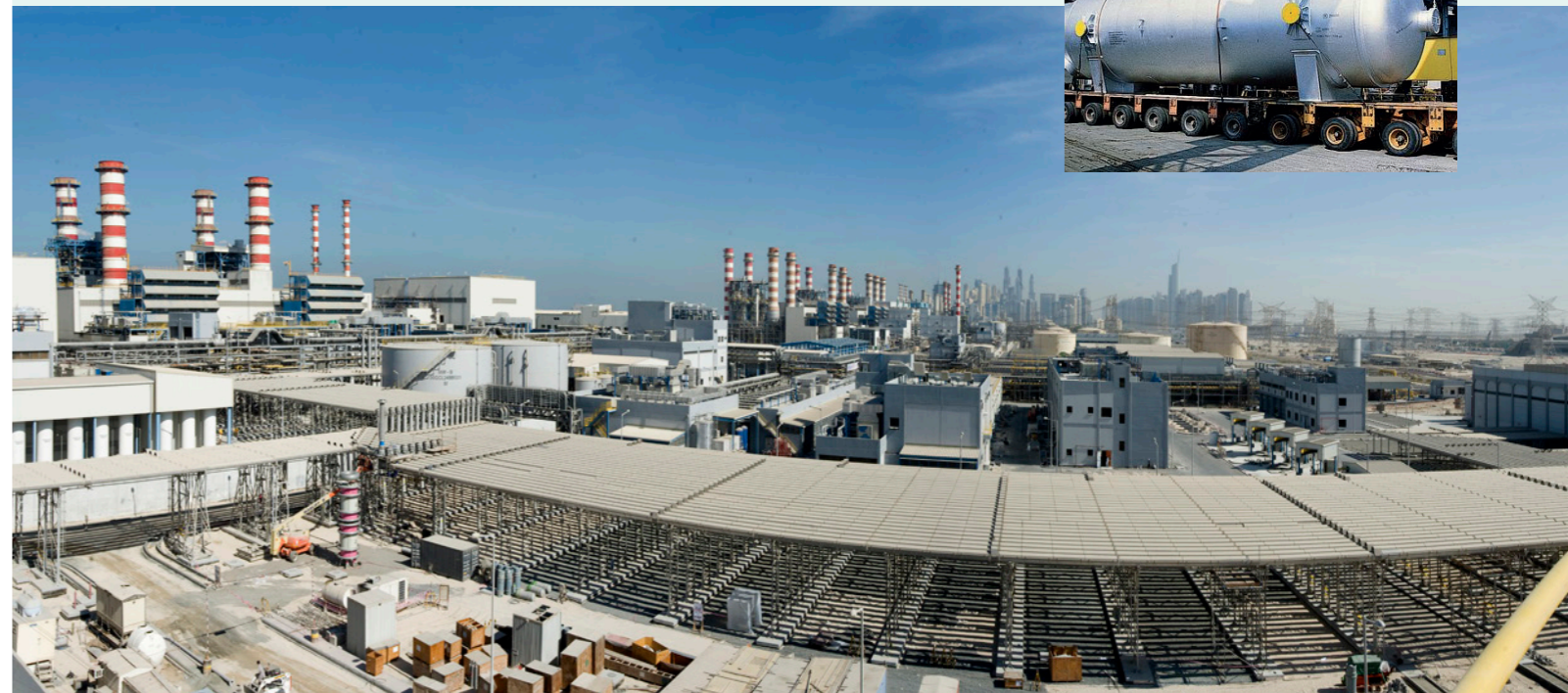
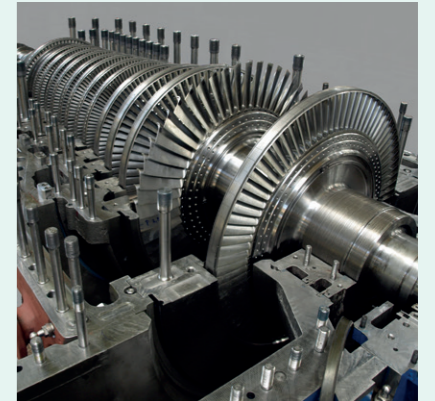



Infrastructure

**Infrastructure,
with proven
performance
and quality**



Technological expertise

Doosan has formed Global One Team with our R&D and engineering experts around the world. Government organizations, university research centers and private institutions are our partners for building reliable technologies. Based on this strong network, we collect voices of the market and move forward with agility and sensitivity.

Doosan's gas turbine development program is being led by the Global R&D Center located in the Republic of Korea, in collaboration with eight technical cooperation groups and more than 200 highly capable subcontractors. Doosan completed the basic design of large size gas turbines in July 2017, the detailed design in 2018, and the prototype manufacturing in 2019. Doosan gas turbines will remain as the mainstream product which will continue to demonstrate top-tier performance and efficiency. Our global networks and partners monitor market trends and reflect them in the short- and long-term roadmaps.

ATSA is Doosan Gas Turbine R&D Office located in the U.S., consisting of renowned compressor and combustor experts. They research and develop compressor front stage and advanced combustor design, which are key determinants of gas turbine performance and operability. ATSE is Doosan Gas Turbine R&D Office located in Switzerland, with strong expertise in designing turbine blades and vanes. The Global One Team takes pride in delivering excellence to the power generation market by creating reliable, robust and highly efficient gas turbines.



ATSE (Advanced Turbomachinery System Europe)



Doosan R&D Headquarter



DTS (Doosan Turbomachinery Services)



ATSA (Advanced Turbomachinery System America)

α to Ω manufacturing facilities

Doosan is completing the entire process of gas turbine manufacturing from casting-forging to assembly in its own facility, a single site with the ground area of 4,429,000m². This in-house facility has an annual production capacity of 2.7GW, and especially, it has a hot part factory with more than 44 types of equipment for hot part manufacturing including special machining, coating, welding & brazing, heat treatment, repair and inspection.

Doosan's hot part factory operates special manufacturing equipment including EDM/LASER cooling hole machining equipment, die-sinking EDM equipment, creep feed grinding machines, welding/brazing equipment, TBC coating equipment, vacuum heat treatment furnace and ultrasonic/vapor degreasing cleaning equipment, as well as quality inspection equipment including air flow test, moment weight test, tapping test and non-destructive inspection devices.

- **Creep Feed Grinding:**
Blade fir tree shape machining and vane assembly face mill.
- **Drill EDM & LASER Cooling hole machining:**
Cylindrical cooling hole and fan shape hole for HGPC(Hot Gas Path Component) parts.
- **Die Sinking EDM:**
Vane seal slot, blade damper pin groove and counter bore for brazing preparation machining.
- **Welding and Brazing:**
Low crack sensitivity welding technology with low heat input TIG, micro plasma welding and vacuum brazing.
- **Coating:**
Thermal barrier coating with APS(Air Plasma Spray), HVOF(High Velocity Oxygen Fuel), VPS(Vacuum Plasma Spray) on the surface of HGPCs, and anti-erosion/corrosion coating of internal flow paths with VPA(Vapor Phase Aluminate).
- **Heat Treatment:**
Vacuum heat treatment furnace and technology capable of solution, coating diffusion and aging heat treatment for nickel superalloy materials.

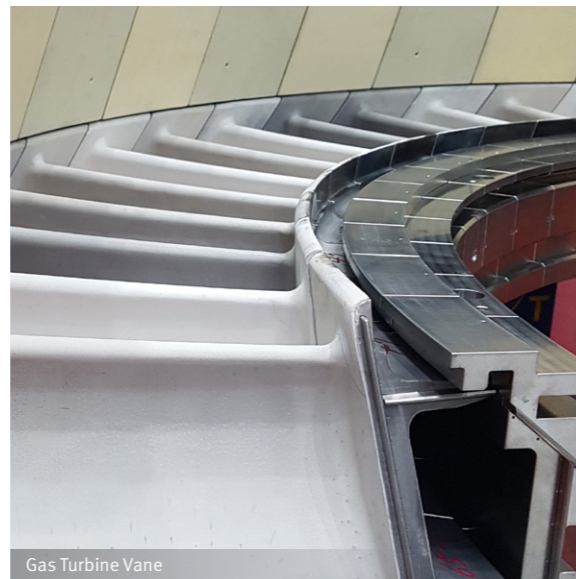

Gas Turbine Vane



Full Scale Full Load Test Facility

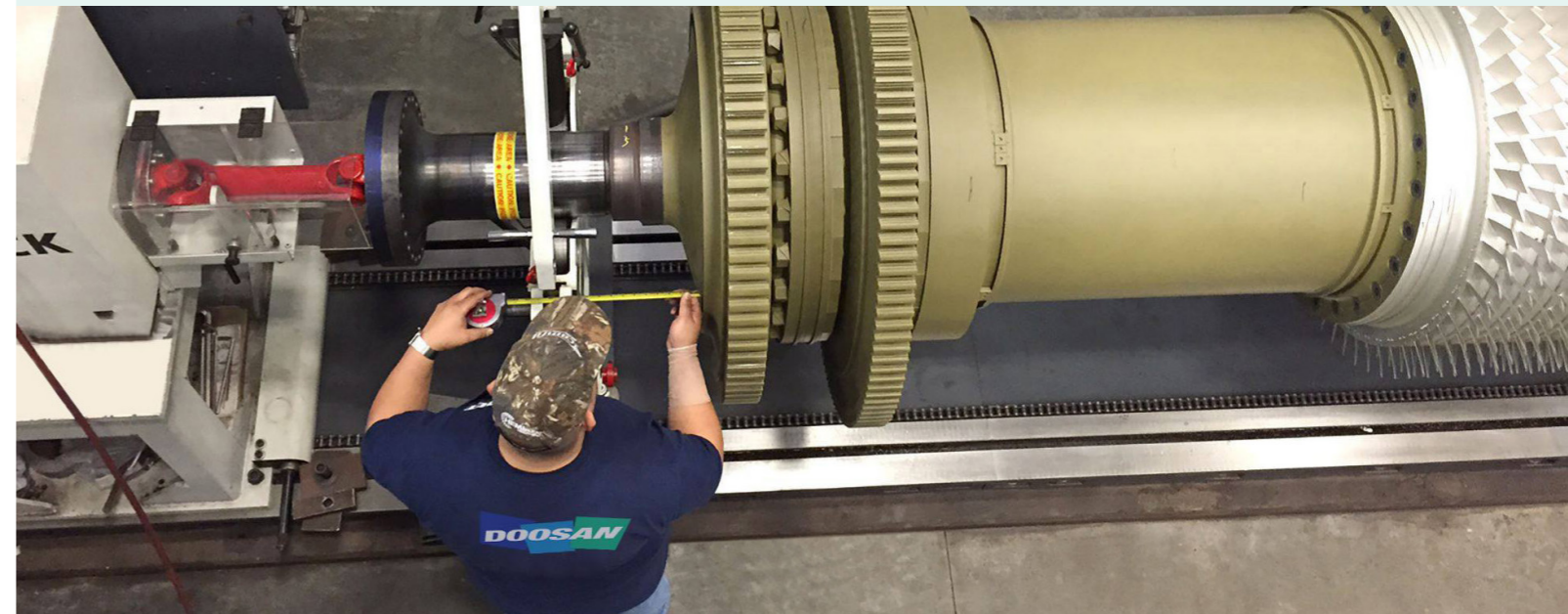
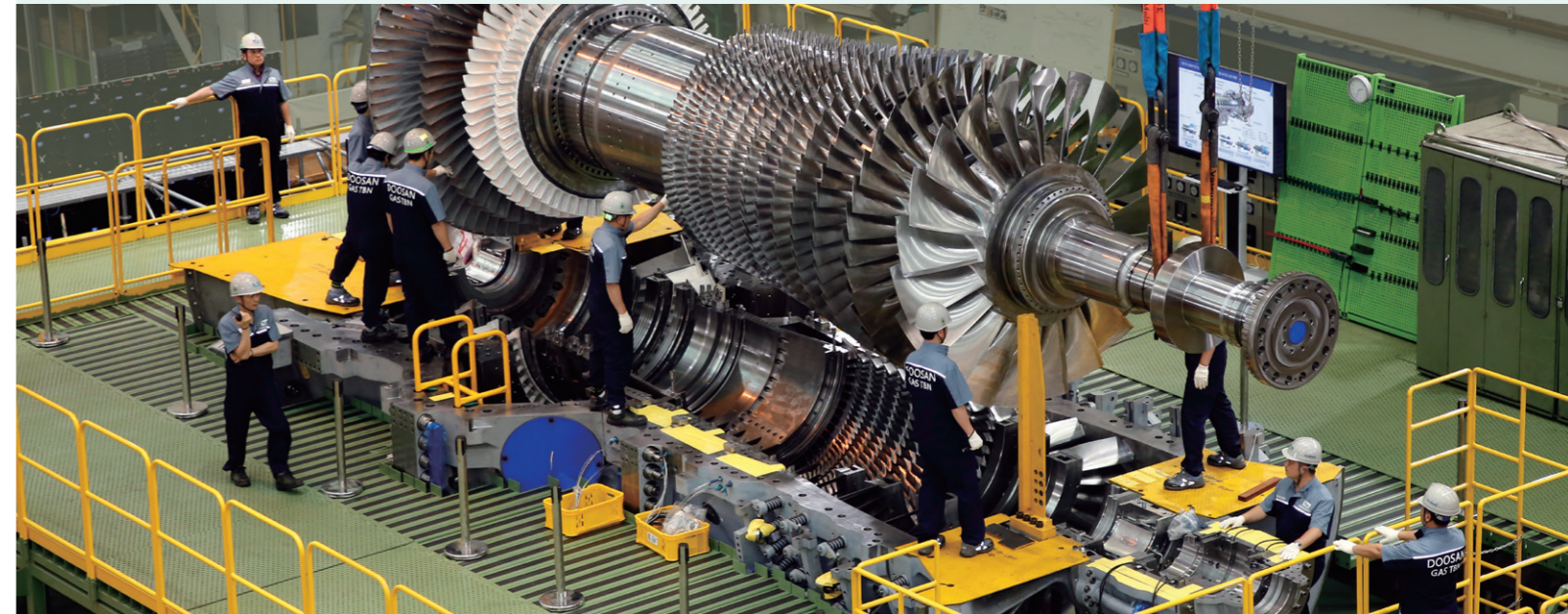

Doosan also has proven manufacturing and engineering capabilities and qualified manpower dedicated to each manufacturing process, for mass production of OEM GT hot parts and development of optimum process parameters for newly developed GT hot parts. We have introduced PLM (Product Lifecycle Management) and MES (Manufacturing Execution System) to our hot part factory to link design information with production process route and to record/manage/track the manufacturing history of hot parts by serial number.

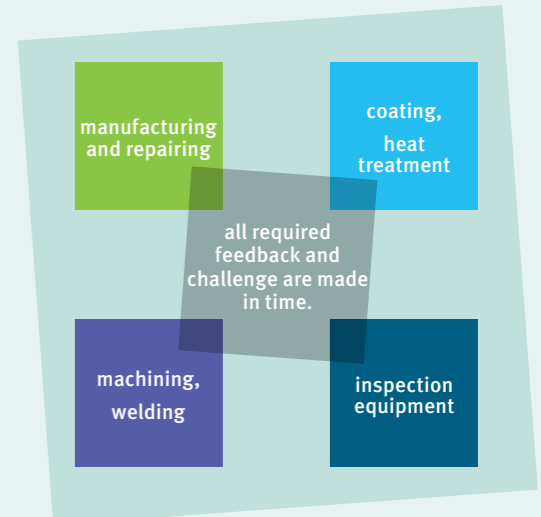

Providing performance and reliability

Doosan is operating the world's largest and most comprehensive full-speed, full-load in-house gas turbine test facility in Changwon, Korea. Providing 50Hz and 60Hz full-range off-grid tests, this grand-scale facility enables operation independent of the grid to verify turbine performance not only in normal conditions but also under unexpected pressure. Over 2,500 instruments are used to collect data on all aspects of gas turbine components and operation, during a validation phase.



Full Scale Full Load Test Facility



Gas Turbine Combustor Test Facility



Gas Turbine Hot Part Manufacturing Facility



Full Scale Full Load Test Facility

Doosan has established a full-scale gas turbine test facility with a site area of 18,900m² and a building area of 9,200m² in the Changwon plant. It performs various tests for performance evaluation and design validation of gas turbines. Especially, these performance tests are conducted under a variety of different load conditions and operating conditions that cannot be implemented in power plants, in order to clearly verify the design, performance, operability and durability of gas turbines.

Doosan's gas turbine test facility consists of two Centers. One of them is Test Operation Center, where experienced test engineers operate test equipment to replicate various test conditions and monitor the status of gas turbines in real-time during the test. The other is Data Management Center, where approximately 50 engineers validate design by monitoring the temperature, pressure and vibration of compressors, combustors and turbines during the test and by analyzing the data. More than 2,500 sensors installed on gas turbines for design validation are also designed and installed hands-on by our instrumentation engineers.

This test facility runs a data acquisition system that can measure a total of 3,500 gas turbine parameters. It can measure about 2,500 data points for temperature/pressure and 500 data points for stress/combustion pulsation/vibration. On top of them, it also has an exhaust gas measuring system, devices to measure uncontact vibration and dynamic range of compressors/turbine blades, as well as a telemetry system to measure the stress/temperature of rotors rotating at a high speed.

Doosan has secured competitiveness in all areas of gas turbine design, fabrication, quality, test and services, placing the highest priority on delivering outstanding quality and services throughout the entire life cycle of gas turbines, and thereby maximizing customer satisfaction. Especially, we have established a gas turbine test infrastructure to ensure thorough in-house performance evaluation and design validation prior to market launch, and it is currently being used as a test bed for developing next-generation models.

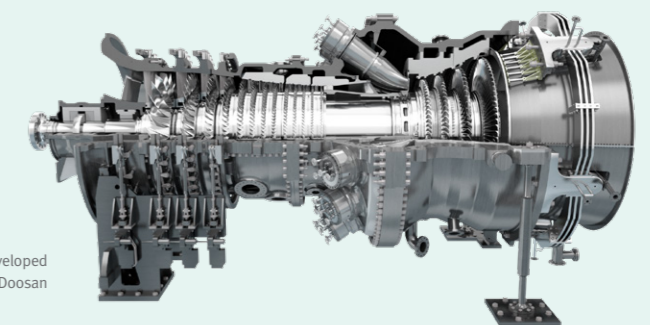

Gas Turbine Model Developed Independently by Doosan



Service

Full range of services

Providing customized services



SERVICES

Each plant in operation requires different types of warranty services that fit its purpose. They could be simply a supply of parts, or a diagnosis program to identify the residual value and life of a plant and to determine the right replacement items. Therefore, identifying plant status and suggesting competitive options are the key to improving plant profitability. Reverse engineering and upgrade are other options for plant life extension, and replacement items are subject to discussion. We propose economic feasibility study results for efficient plant operation, and our customers can always choose the best solution.



NON-OEM UPGRADE

Our highly specialized engineers strive to enhance customers' products to innovate the performance of their existing plants. Timely part supply and repair are key factors in achieving the best performance and operation, and the same applies to non-OEM equipment. Based on our extensive references, we provide not only non-OEM parts but also reverse engineering and upgrade.



SERVICE FACILITY

Doosan Turbomachinery Services was founded in 1996, initially offering gas turbine component repair services. Over the past decade, we have invested tens of millions of dollars in expanding our capabilities, offering additional services and hiring the best talents in the industry to become a truly independent full-service provider for gas and steam turbines. Our state-of-the-art facility in La Porte, Texas, enables us to meet all of our clients' needs.

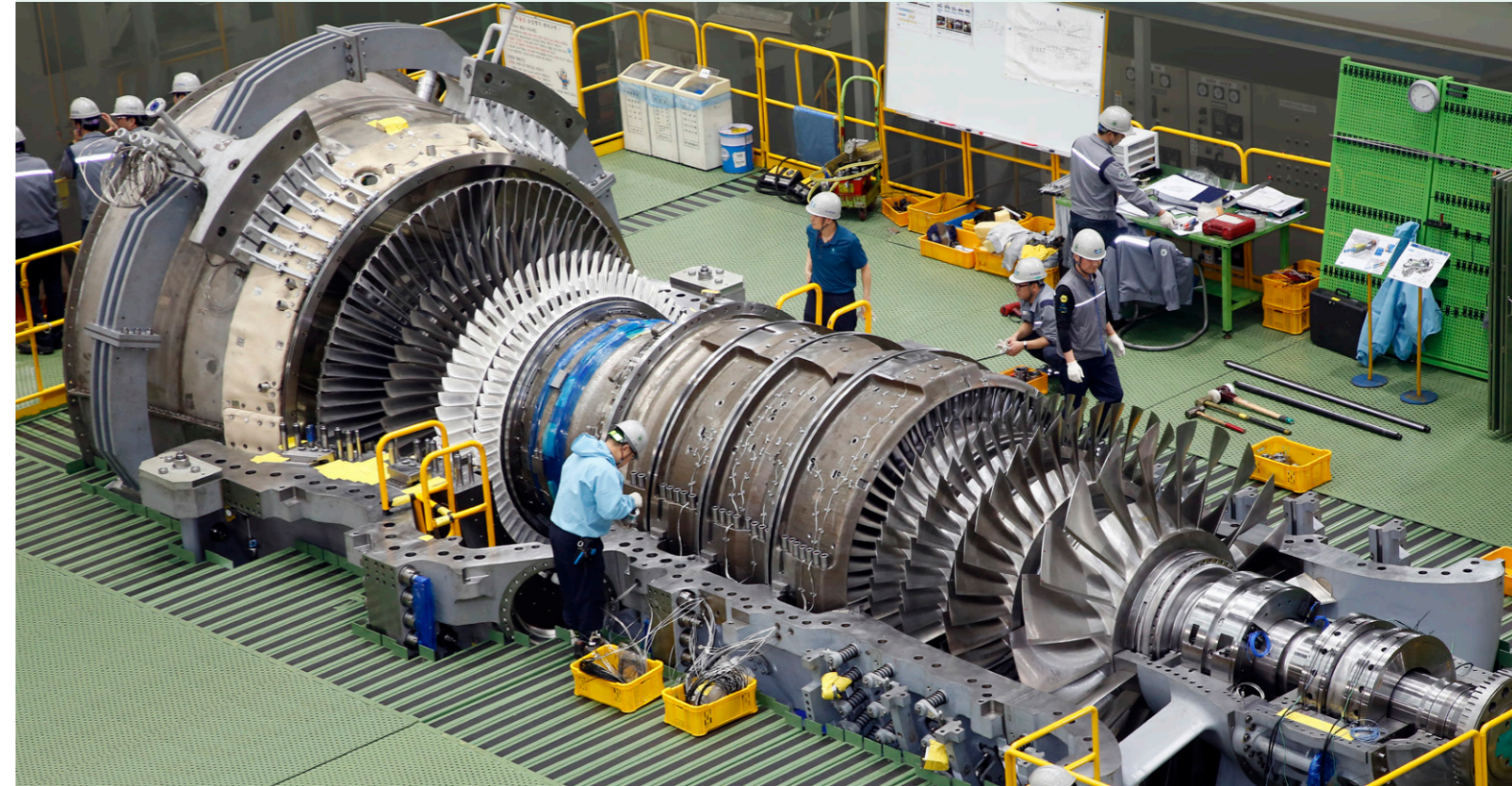

MAJOR ACCOMPLISHMENTS

A gas turbine model developed independently by Doosan is scheduled to be installed at the Gimpo Combined Heat & Power (CHP) plant of the Korea Western Power Co., Ltd. (KOWEPO), where a demonstration run will take place in 2023. In addition, Doosan is capable of supplying local-manufactured large-size gas turbines and providing maintenance and parts replacement. We have received orders for the fuel conversion project of the Hanllim Combined Cycle Power Plant and the maintenance of the Ulsan Combined Cycle Power Plant. The maintenance of the exhaust cylinder of three gas turbines installed at the Ulsan CCGP Unit No. 4 to 6, another project won by Doosan, was the first case where a local Korean company emerged victorious over global competitors, winning a maintenance service contract.

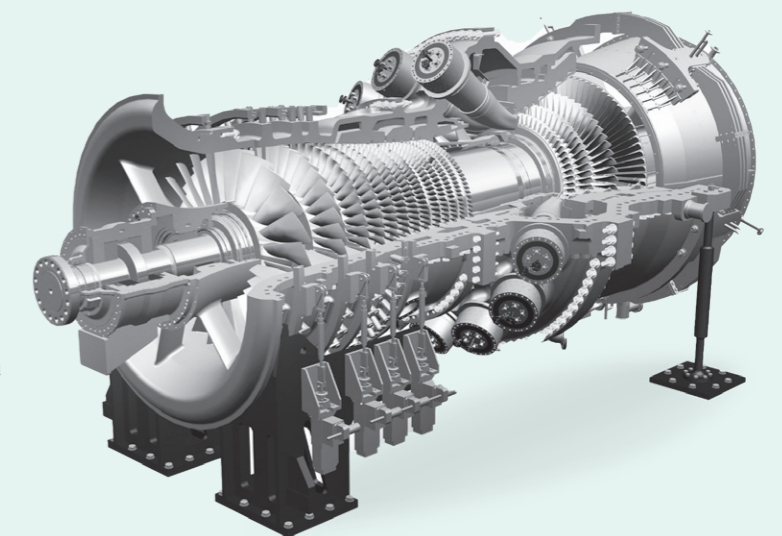

Gas Turbine Model
Developed
Independently by
Doosan

The way we work

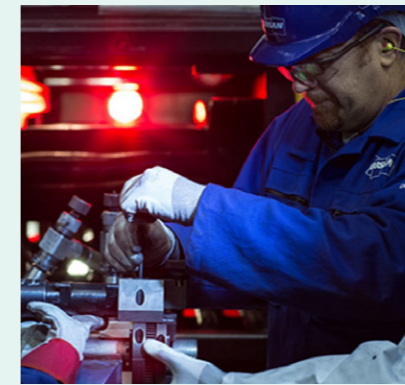

As a global partner of your life, Doosan sets up the highest standards in all aspects—technology, quality, service, and strong networks. We are focusing on creating value for customers beyond what is inherent in the product or service itself. We always put people at the center of what we do.

We take genuine care in people development, making their cultivation our long-term priority. We are also committed to the education of our youth, to ensure we develop a new pipeline of technologies, design, engineering and project management talent and retain an unparalleled breadth of knowledge within our company.



Transferring knowledge and experience to the next generation strengthens the stability and longevity of our business, and gives our customers reassurance that our engineering competency is sustainable in the long term.

Doosan is scheduled to reorganize the core business structure drastically as a professional energy company. With a project portfolio focusing on gas and new renewable energy, Doosan will be reinvigorated as a leading enterprise that creates social value through its core businesses. Doosan's core businesses, technologies that maximize energy efficiency and reduce greenhouse gas – will contribute to making a clean earth.



For effective management, Doosan has established the ESG Committee, chaired by the CEO, which is the top ESG decision-making authority tasked with the role of identifying global trends, responding swiftly to regulatory demands, examining the company's sustainability performance and sharing/discussing the initiatives devised to achieve the business goals.

The Committee consists of three sub-committees – the Environment, Social and Governance & Economy sub-committees. Under the lead of the Committee Chairman, the executive members of the sub-committees convene a meeting once a year to hold in-depth discussions on strategies for achieving sustainable management.



Doosan Heavy Industries & Construction

Headquarter

22 DoosanVolvo ro , Seongsan gu
Changwon si , Gyeongnam 51711, Korea
(T) +82 55 278 6114, 7114

Doosan Bundang Center

155 Jeongjail ro , Bundang gu , Seongnam si
Gyeonggi do 13557, Korea

Doosan Turbomachinery Services

12000 N. P Street La Porte,
Texas 77571 . U.S.A
(T) 1 713 364 7500